









# NUNA | CORTINA CRISTAL CORREDERA SLIDING GLASS WALL



Las aperturas correderas **NUNA** son rápidas y fáciles de manejar. Su rendimiento es óptimo gracias a la fortaleza de sus sujeciones, que permiten deslizar las hojas rápida y cómodamente hasta el lugar elegido.

**NUNA** sliding openings are fast and easy to operate. Their optimal performance comes from the strength of their anchoring system, which allows the panels to slide quickly and comfortably to the desired position.

**NUNA** dispone de un sistema que se adapta a las condiciones constructivas de la instalación para asegurar el deslizamiento secuencial de las hojas que componen la cortina corredera de cristal.

**NUNA** has a system that adjusts to the structural conditions of the installation to ensure automatic, sequential movement of the panels that make up the sliding glass curtain.

Este modelo es el más recomendado para instalaciones de uso intensivo y de grandes dimensiones. Los paneles de cristal se apoyan y desplazan por las guías del suelo, evitando que la estructura tenga que soportar su peso.

This model is the most suitable one for large, intensive-use installations. The glass panels sit inside and slide along bottom floor guides, so the structure does not have to support their weight.

## VENTAJAS | HIGHLIGHTS



TEMPERATURA ÓPTIMA  
OPTIMAL TEMPERATURE



ACABADOS INOX  
INOX FINISHES



REDUCCIÓN SONORA  
SOUND REDUCTION



VISTA SIN OBSTÁCULOS  
VIEW WITHOUT OBSTACLES

## COLORES | COLOURS



RAL 9016  
-909+09016  
Blanco tráfico  
Traffic White



RAL 9010  
-909+09010  
Blanco puro  
Pure White



RAL 1013  
-909+01013  
Blanco Ostra  
Oyster white



RAL 1013  
-909+01413  
Blanco Ostra textura  
Texture Oyster white



RAL 1015  
-909+01015  
Marfil claro  
Light Ivory



ÓXIDO  
-909+00516  
Corten textura  
Mars sablé



RAL 8014  
-909+08014  
Marrón Sepia  
Sepia Brown



RAL 7040  
-909+07040  
Gris ventana  
Window grey



DB703  
-909+99703  
Antracita metálico  
Metallic anthracite



RAL 7012  
-909+07012  
Gris basalto  
Basalt Grey



RAL 7022  
-909+07022  
Gris sombra  
Umbra Grey



RAL 7016  
-909+07016  
Gris Antracita  
Anthracite grey



RAL 7016  
-909+07416  
Antracita textura  
Texture Anthracite



RAL 9011  
-909+09011  
Negro grafito  
Graphite black



RAL 9005  
-909+9405  
Negro textura  
Texture Black

Libre elección entre 15 colores al mismo precio. Consultar otras opciones.

Choice of 15 colours at the same price. Enquire about other options.



SECCIONES DE PERFILES | PROFILE SECTIONS (mm)

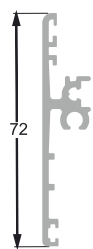

PERFIL HOJA  
SHEET PROFILE



TAPA HOJA  
LID COVER



SUJECIÓN HOJA  
PANEL HOLDER

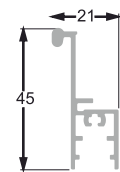

HOJA CIERRE  
SHEET CLOSURE

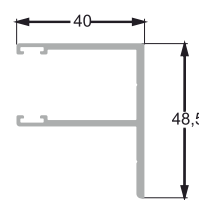

MARCO LATERAL  
SIDE FRAME

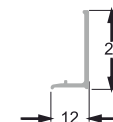

TAPA HOJA CIERRE  
LID SHEET COVER

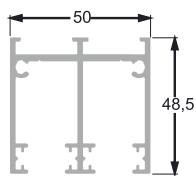

MARCO SUPERIOR 2 CARRILES  
UPPER FRAME 2 RAILS

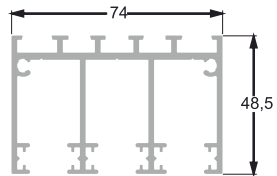

MARCO SUPERIOR 3 CARRILES  
UPPER FRAME 3 RAILS

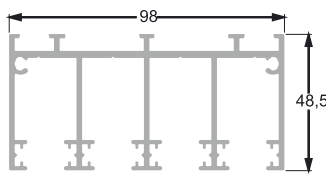

MARCO SUPERIOR 4 CARRILES  
UPPER FRAME 4 RAILS

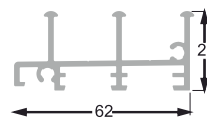

MARCO INFERIOR 2 CARRILES  
BOTTOM FRAME 2 RAILS

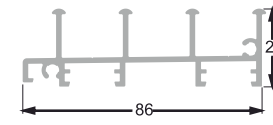

MARCO INFERIOR 3 CARRILES  
BOTTOM FRAME 3 RAILS

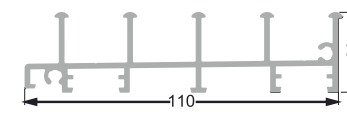

MARCO INFERIOR 4 CARRILES  
BOTTOM FRAME 4 RAILS

## AJUSTABLE A LAS CONDICIONES CONSTRUCTIVAS ADJUSTABLE TO STRUCTURAL CONDITIONS

Los niveladores incorporados en el diseño del marco inferior de aluminio permiten adaptar el sistema a las condiciones constructivas del lugar de la instalación ya que se ajustan  $\pm 2,50$  mm.

Asimismo, los perfiles del marco pueden compensar hasta 20 mm de irregularidad en las superficies sobre las que se van a hacer las fijaciones.

## SIN OBSTÁCULOS DE PASO | CLEAR PASSAGES

La posibilidad de instalar el perfil inferior embutido en el suelo, evita que existan elementos obstaculizando el paso al interior o exterior de la cortina corredera, sea de doble, triple o cuádruple carril.

The levellers built into the design of the bottom aluminium frame allow the system to be adapted to the structural conditions of the point of installation, as they can be adjusted by  $\pm 2.50$  mm.

In addition, the frame profiles can compensate for up to 20 mm of irregularity on the anchoring surface.

The possibility of inlaying the bottom profile in the floor prevents any component from blocking the passageway through the opening in the sliding curtain, whether it is a double, triple or quadruple channel.



## ESPECIFICACIONES TÉCNICAS | TECHNICAL SPECIFICATIONS

- Sistema de carriles de 2 a 8 hojas.
- Montaje rápido y en seco para mayor comodidad y mejores resultados
- Regulaciones y compensaciones
  - Regulaciones
    - Ajuste de la hoja a los carriles: hasta 2 mm
    - Desde punto medio:  $\pm 2,5$  mm el marco y  $\pm 3,5$  mm las hojas
  - Compensaciones | Compensations:
    - Carril inferior:  $\pm 2,5$  mm
    - Marco total: 20 mm
- Pesos:
  - Los rodamientos de aguja permiten soportar hasta 65 kg
  - Peso máximo de cada panel: 80 kg
- Dimensiones máximas hojas de vidrio templado:
  - Alto: 3000 mm
  - Ancho: 1600 mm
  - Grosor: 10 mm

## TECHNICAL SPECIFICATIONS

- Channel system for 2 to 8 panels.
- Fast, dry assembly for improved comfort and better results.
- Adjustments and compensations:
  - Adjustment
    - Adjustment of panels to channels: up to 2 mm
    - From midpoint:  $\pm 2.5$  mm for the frame and  $\pm 3.5$  mm for the panels
  - Compensations:
    - Bottom channel:  $\pm 2.5$  mm
    - Total frame: 20 mm
- Weights:
  - The needle roller bearings can bear loads up to 65 kg
  - Maximum weight of each panel: 80 kg
- Maximum dimensions of tempered glass panels:
  - Height: 3000 mm
  - Width: 1600 mm
  - Thickness: 10 mm



# NUNA

CORTINA CRISTAL  
CORREDERA  
SLIDING GLASS WALL

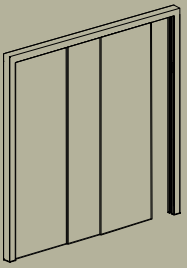

## DIMENSIONES MÁXIMAS | MAXIMUM DIMENSIONS (mm)

Línea Width	Altura Height
7000	3000

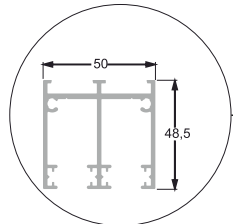

Marco superior 2 carriles  
Upper frame 2 rails

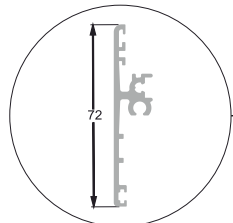

Perfil hoja  
Sheet profile

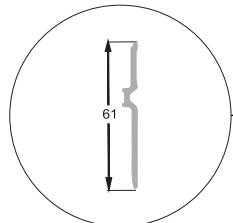

Tapa hoja  
Lid cover

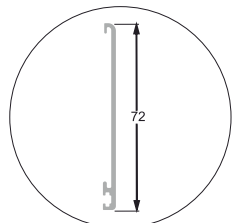

Sujeción hoja  
Panel holder

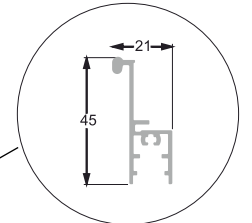
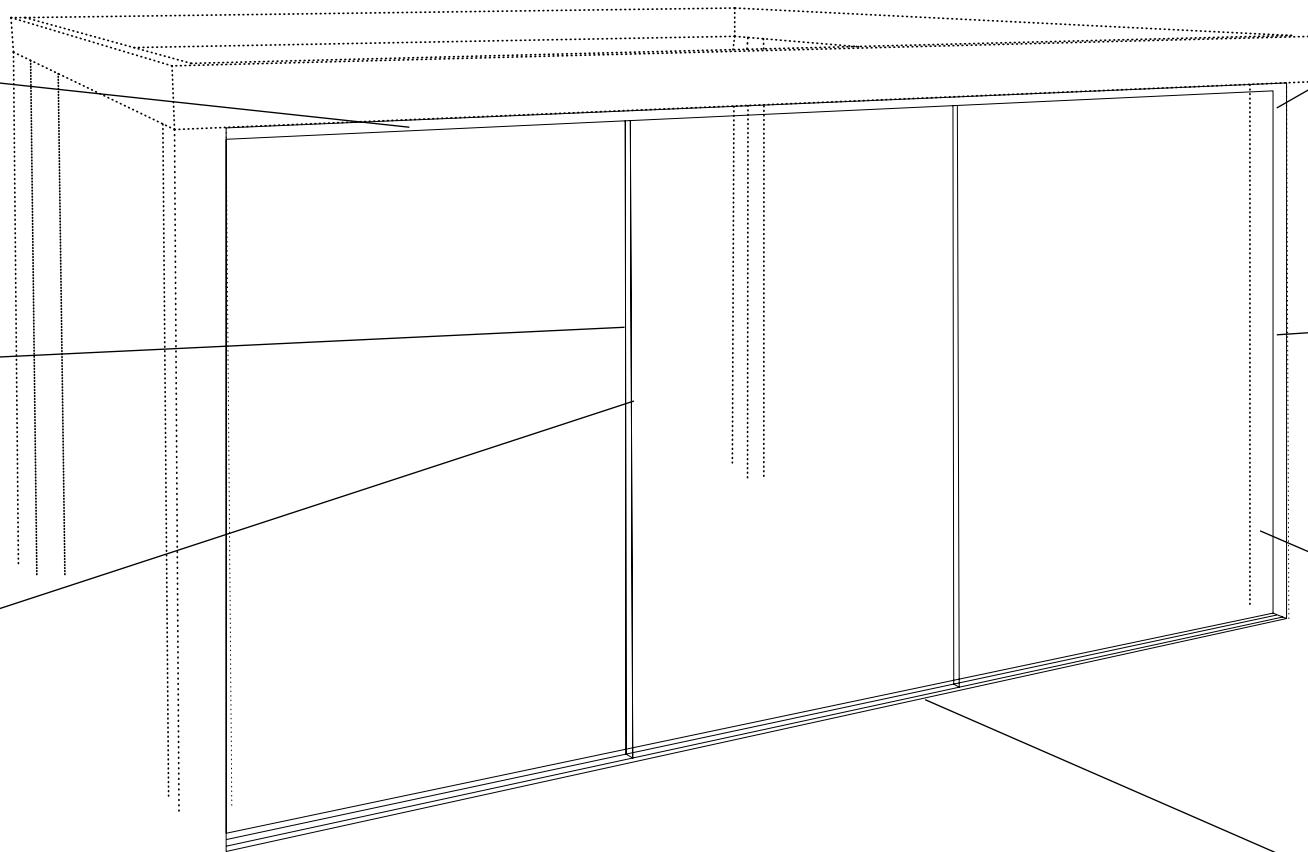

Hoja cierre  
Sheet closure

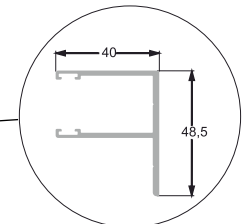

Marco lateral  
Side frame

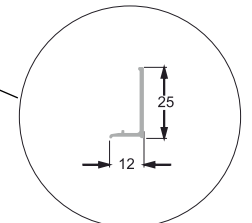

Tapa hoja cierre  
Lid sheet cover

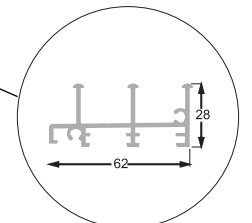

Marco inferior 2 carriles  
Bottom frame 2 rails

OPCIONES DE MONTAJE | MOUNTING OPTIONS

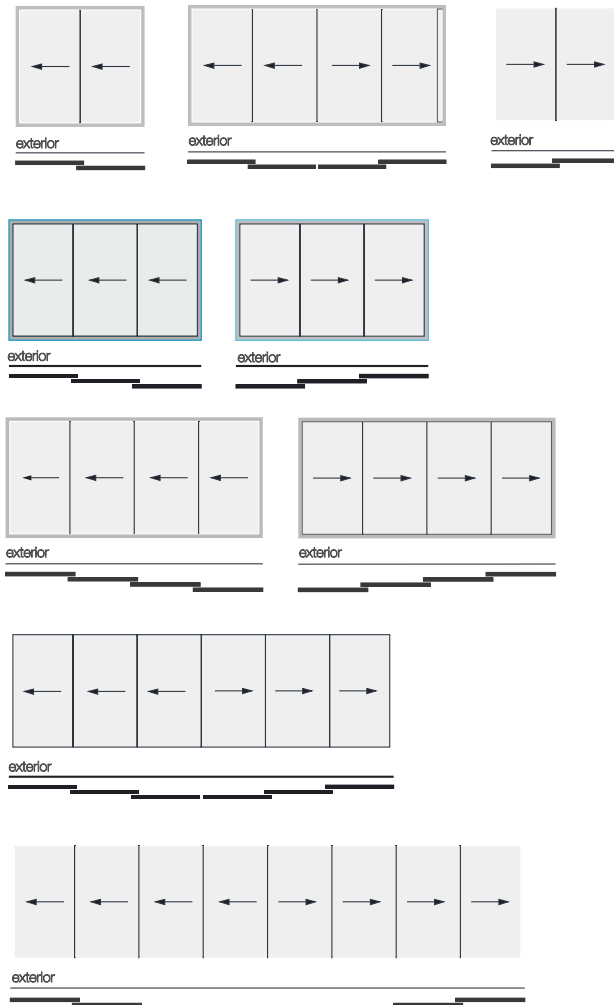

(mm)

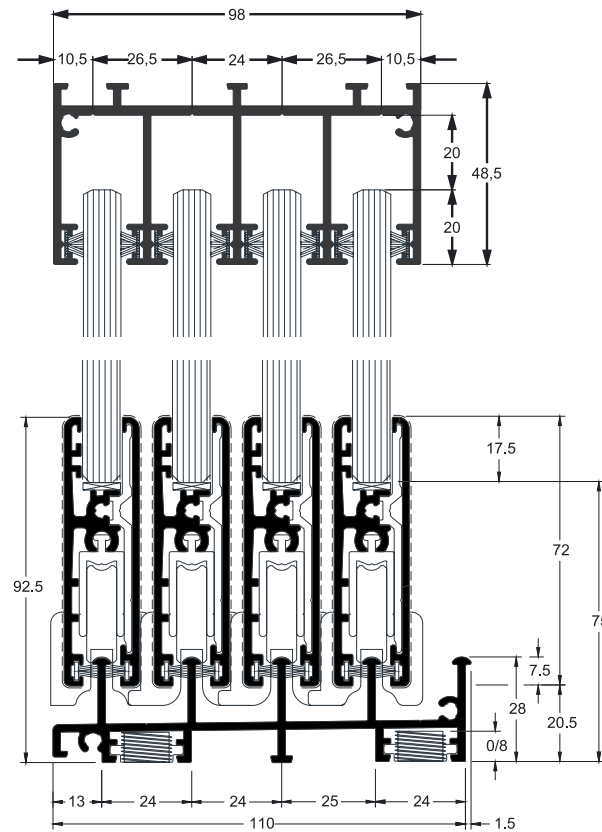

Dimensiones hoja de vidrio templado  
Tempered glass sheet dimensions

ALTO | HEIGHT (mm)

